

Kleuren/Farben/colors:

- Humbrol 26, 33, 53, 56, 62, 66, 78, 113, 155

- Lijm resin en messing onderdelen met seconde-lijm (cyanoacrylaat).
- Zum verkleben verwenden Sie Cyanoacrylate.
- Glue resin and brass parts with Cyanoacrylate.

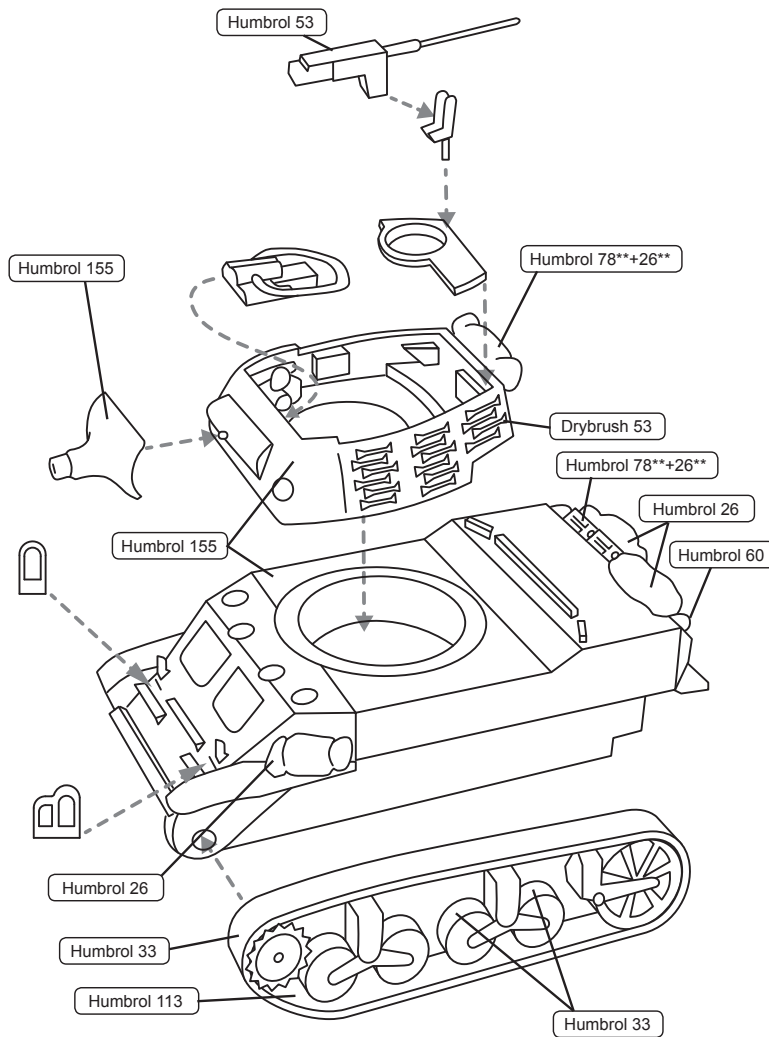

Product made in Holland
© ARTITEC 2012

1:87 | H0

Kleuren/Farben/colors:

- Humbrol 26, 33, 53, 56, 62, 66, 78, 113, 155

- Lijm resin en messing onderdelen met seconde-lijm (cyanoacrylaat).
- Zum verkleben verwenden Sie Cyanoacrylate.
- Glue resin and brass parts with Cyanoacrylate.

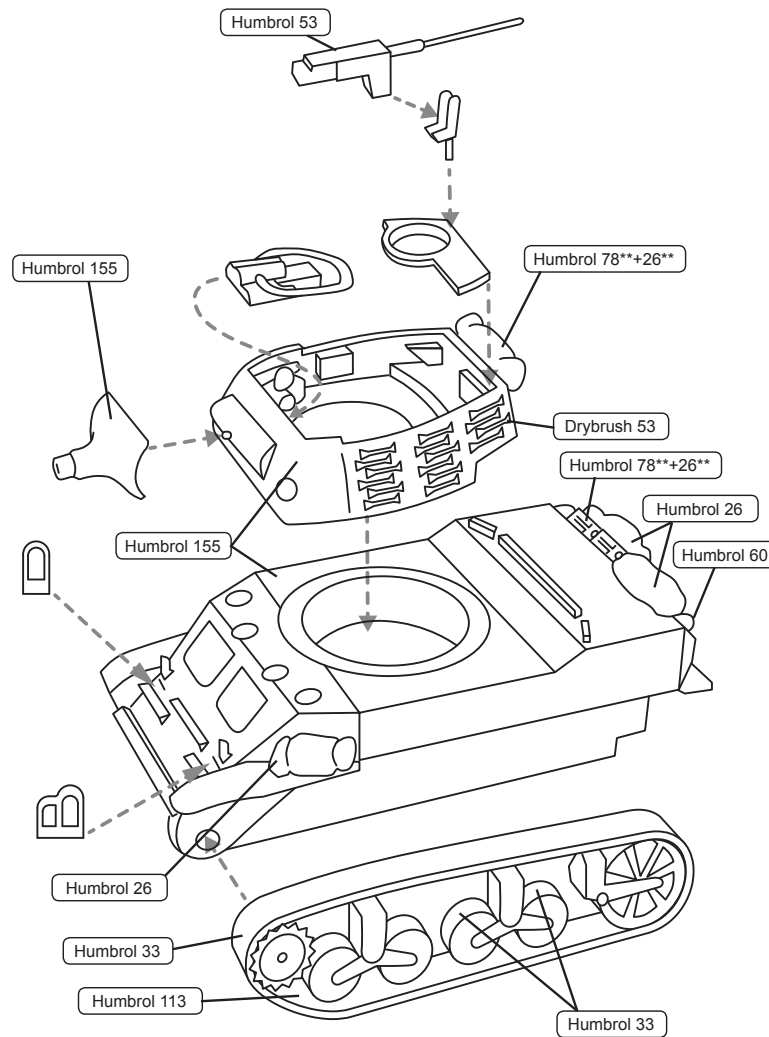

Product made in Holland
© ARTITEC 2012

1:87 | H0